

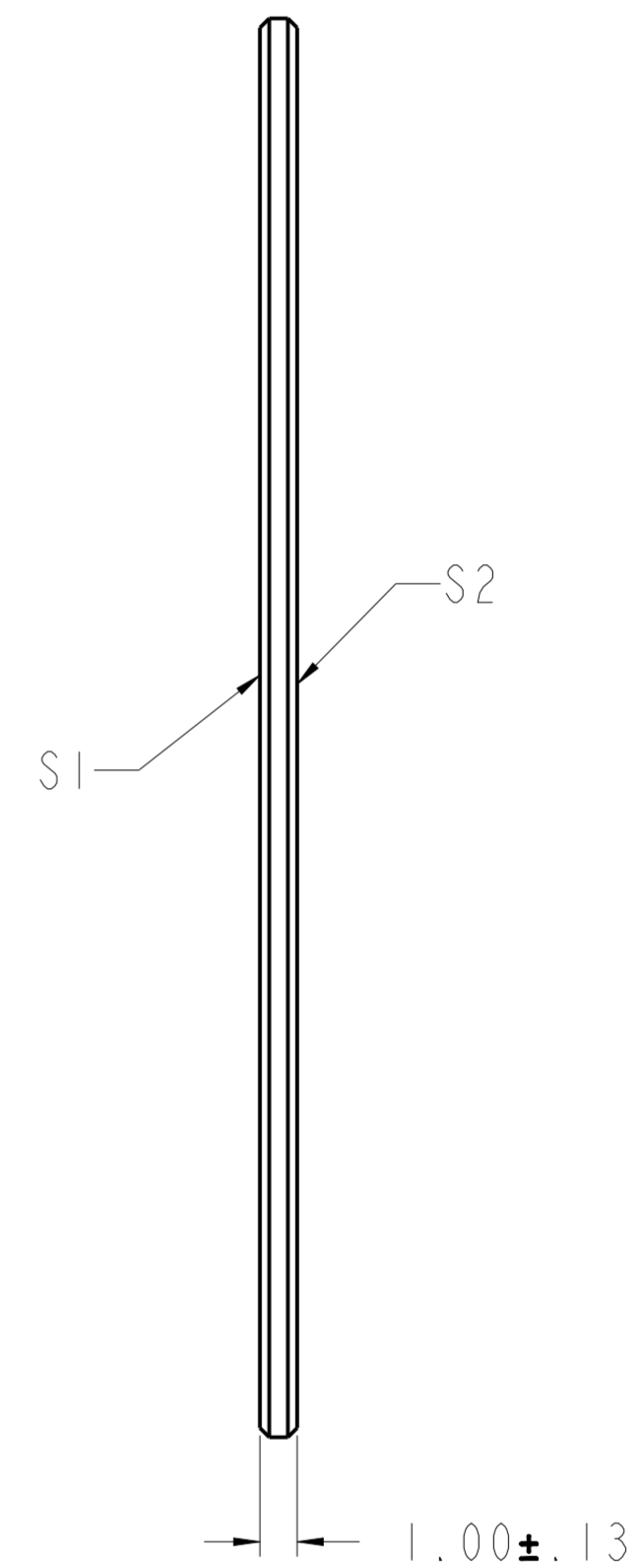

NOTES:

1. MATERIAL: CaF2
2. CLEAR APERTURE: 85%
3. PARALLELISM: (S1&S2) 3 ARC MIN
4. FLATNESS: (S1&S2) 2 WAVES PER INCH @ 633 nm
5. SURFACE FINISH: (S1&S2) 40/20
6. UNCOATED

REVISION HISTORY				
REV	DCO	DESCRIPTION	DATE	INITIALS
A	6016	INITIAL RELEASE	11/26/19	BH

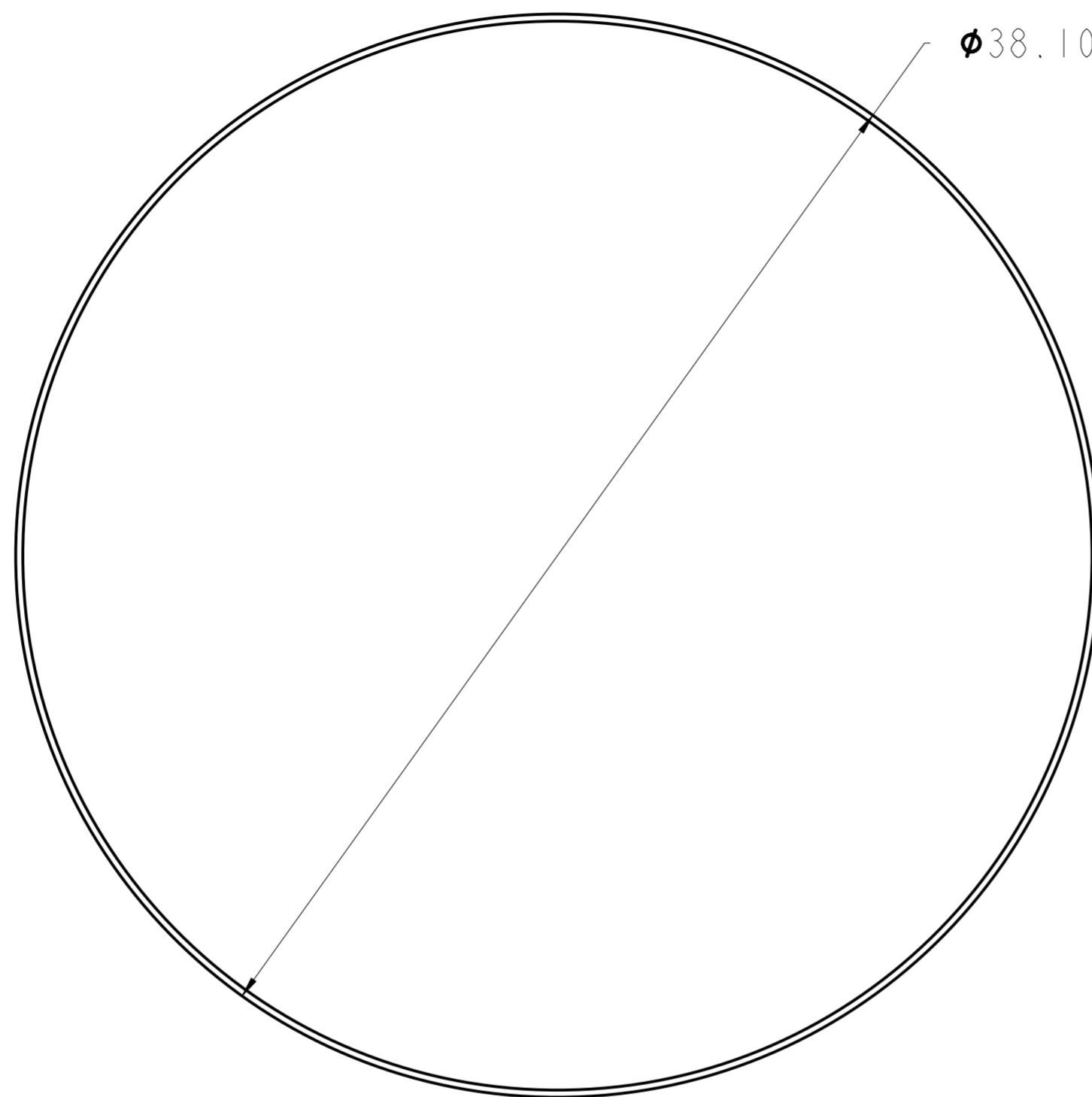

REFERENCE ONLY  
NOT FOR MANUFACTURING

UNLESS OTHERWISE SPECIFIED DIMENSIONS ARE IN MM. DECIMAL TOLERANCES ARE: .X ± 0.25 .XX ± 0.10 .XXX ± 0.025 .XXXX ± 0.013 ANGLES: ± 0.5°		 <b>ISPOPTICS</b> LightPath		PROPRIETARY INFORMATION THIS DOCUMENT CONTAINS PROPRIETARY INFORMATION OF LIGHTPATH TECHNOLOGIES AND IS NOT TO BE DISCLOSED OR REPRODUCED IN WHOLE OR PART, OR USED FOR MANUFACTURING FOR ANYONE OTHER THAN LIGHTPATH TECHNOLOGIES WITHOUT ITS WRITTEN CONSENT. NO RIGHT IS GRANTED TO DISCLOSE OR USE ANY INFORMATION CONTAINED IN SAID DOCUMENT.	
DRAWN BH		TITLE WINDOW - CaF2 - 38.1 X 1.0			
MATERIAL CaF2	SIZE A2	DWG NO CF-W-38-1 - CAT		REV A	
SOFTWARE Pro/ENGINEER	SCALE: 5.00	THIRD ANGLE PROJECTION		SHEET 1 OF 1	

DWG NO  
CF-W-38-1  
REV  
A