

NOTES:

1. MATERIAL: CaF2
2. CLEAR APERTURE: 85%
3. ANGLE: 3 DEG ± 15 MIN
4. FLATNESS: (SI&S2) 2 WAVES PER INCH @ 633 nm
5. SURFACE FINISH: (SI&S2) 60/40
6. UNCOATED

REVISION HISTORY				
REV	DCO	DESCRIPTION	DATE	INITIALS
A	6073	INITIAL RELEASE	1/13/20	YK

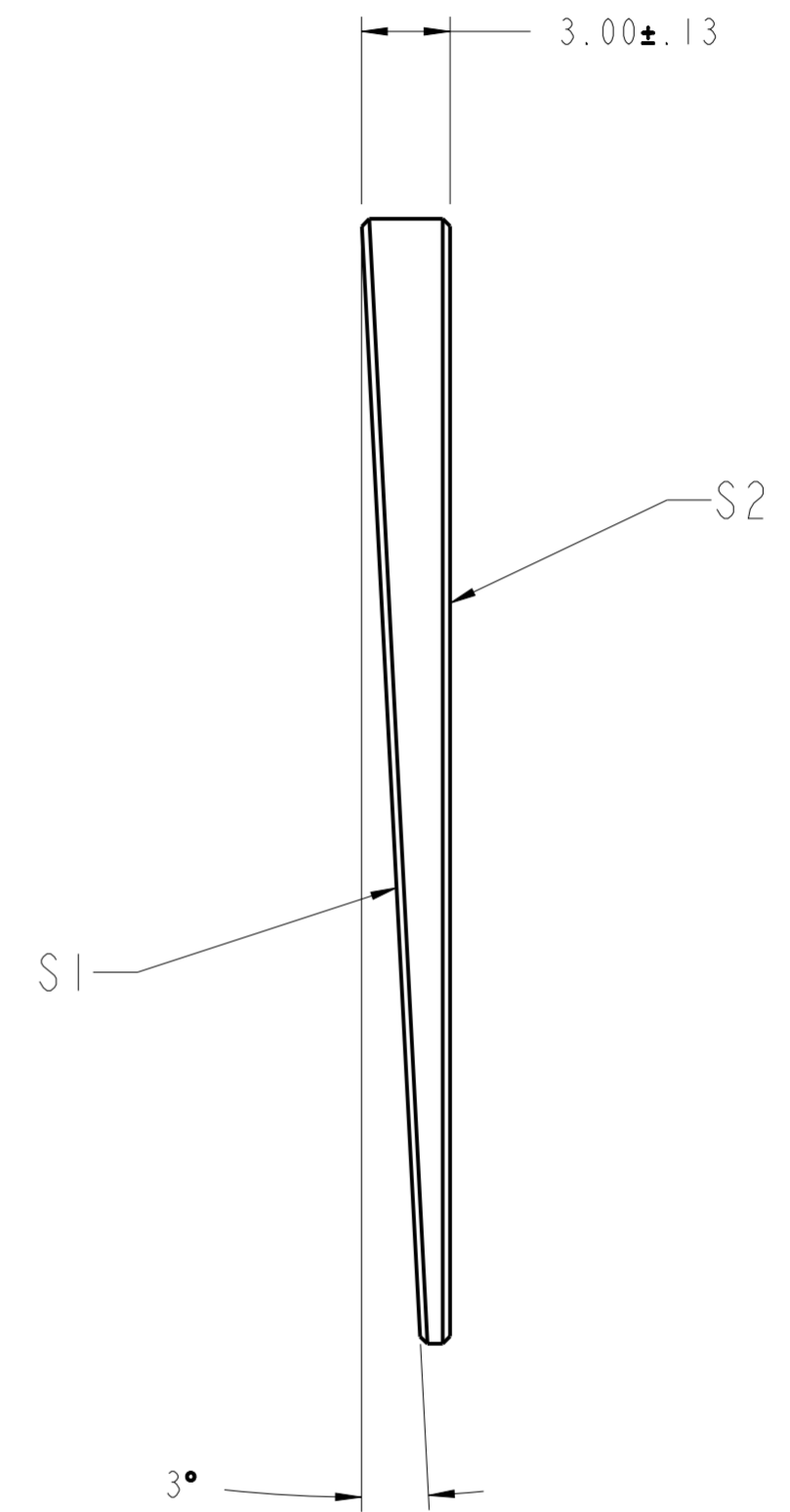
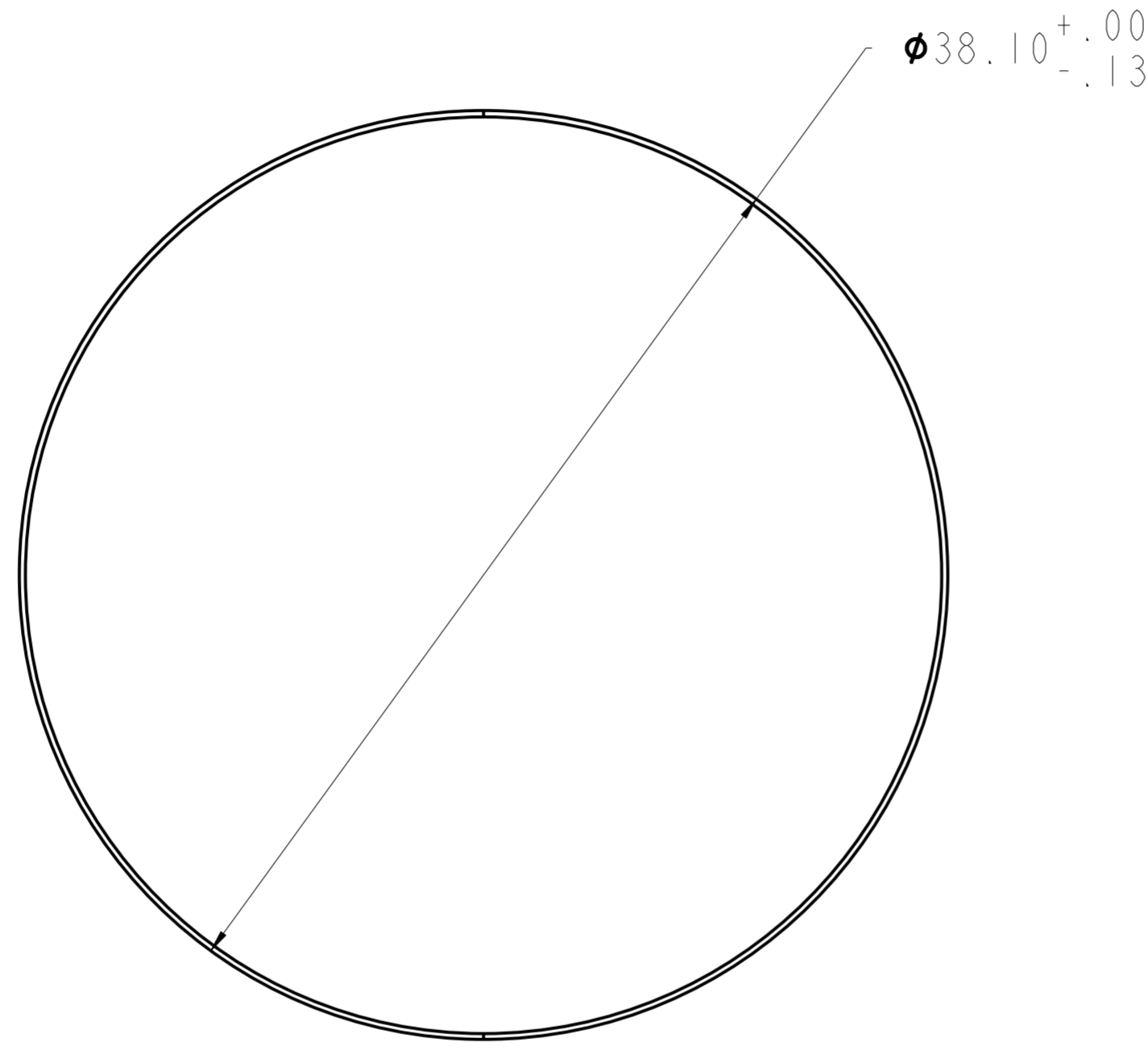

REFERENCE ONLY
NOT FOR MANUFACTURING

UNLESS OTHERWISE SPECIFIED DIMENSIONS ARE IN MM. DECIMAL TOLERANCES ARE: .X ± 0.25 .XX ± 0.10 .XXX ± 0.025 .XXXX ± 0.013 ANGLES: ± 0.5°				<small>PROPRIETARY INFORMATION THIS DOCUMENT CONTAINS PROPRIETARY INFORMATION OF LIGHTPATH TECHNOLOGIES AND IS NOT TO BE DISCLOSED OR REPRODUCED IN WHOLE OR PART, OR USED FOR MANUFACTURING FOR ANYONE OTHER THAN LIGHTPATH TECHNOLOGIES WITHOUT ITS WRITTEN CONSENT. NO RIGHT IS GRANTED TO DISCLOSE OR USE ANY INFORMATION CONTAINED IN SAID DOCUMENT.</small>	
DRAWN YK		TITLE WINDOW WEDGE 3DEG - CaF2 - 38.1 X 3.0			
MATERIAL CaF2	SIZE A2	DWG NO CF-WW3-38-3 - CAT		REV A	
SOFTWARE Pro/ENGINEER	SCALE: 4.00	THIRD ANGLE PROJECTION 		SHEET 1 OF 1	

DWG NO
CF-WW3-38-3